

KDT 3.60

Ersatzteilliste
Spare parts list
Liste de pièces de rechange
Listino pezzi di ricambio
Lista de piezas de recambio
Reserveonderdelenlijst
Reservedelsliste
Reservdelislista

Reservedelsliste
Varaosaluettelo
Wykaz części zamiennych
Seznam náhradních dílů
Tartalékalkatrész lista
Κατάλογος ανταλλακτικών
Перечень запасных частей
备用零件目录
スペアパーツリスト

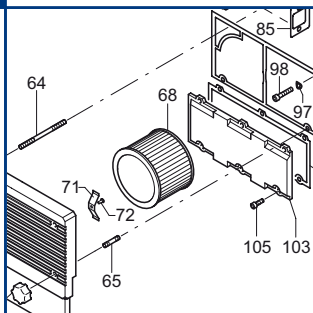

SERVICE

BECKER
Qingou - P.R. CHINA
www.becker-international.com

year

No. **W** **Index Variante**

type **KDT 3.60-XX**

frequency Hz

speed min⁻¹

power required kW

inlet capacity m³/h

pressure + mbar

vacuum - mbar

Made in China

WU 87-1-25

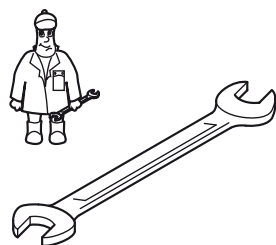

Wartung
Maintenance
Entretien
Manutenzione
Mantenimiento



Pos.	Menge ²⁾ Quantity Quantité Quantità Cantidad	Bestell-Nr. Ident No. No. Identification No. Identificazione No. de pedido	Bezeichnung Description Designation Designazione Descripción
□	1	549000 21100	Dichtungssatz, Complete set of seals, Jeu de joints, Kit di guarnizioni, Junta Completa
11	SATZ/KIT	901330 00004	Schieber, Rotor Vane, Palette, Empujador
11		901379 00004	„ KDT 3.60/0-52
11		901379 00004	„ KDT 3.60/6
11		901401 00007	„ KDT 3.60/0-29
11		901379 00007	„ KDT 3.60/6-29
68	1	909507 00000	Filterpatrone, Filter cartridge, Cartouche Filtrante, Cartuccia filtro, Cartucho de filtro
68	1	909587 00000	„ KDT 3.60/6
91	1	909510 00000	Filterpatrone, Filter cartridge, Cartouche Filtrante, Cartuccia filtro, Cartucho de filtro

²⁾ erforderliche Bestellmenge / necessary order quantity / quantité nécessaire / quantità di ordinazione necessari / cantidad necesario

SERVICE

www.becker-international.com
 Sales and service network

KDT 3.60

Standard



Variante



KDT 3.60/XX

①
US-motor

- ②-⑤
/0-05, /6, 6-29, /0-52
- Korrosionsschutz
- corrosion protection
- protection contre la corrosion
- protezione anti-corrosione
- protección contra la corrosión

- ⑥
/0-54
- Kühlung
- refrigeration
- réfrigération
- refrigerazione
- refrigeración

⑦
B5-200

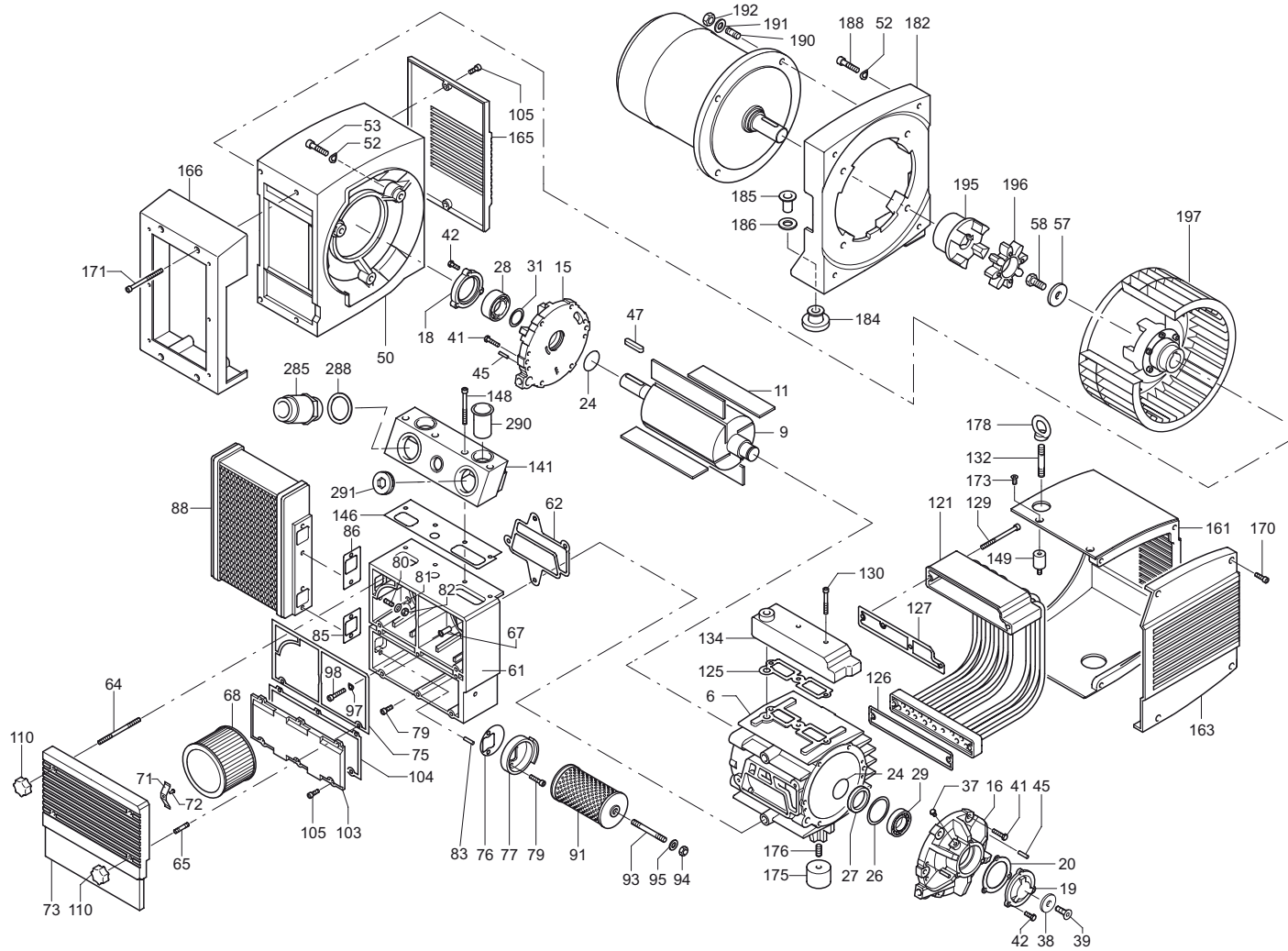

SERVICE ?

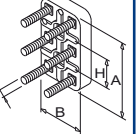
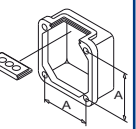
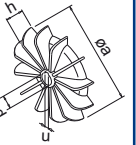
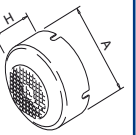
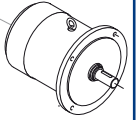



W INDEX	Pos.	Bestell Nr.	Beschreibung	DE	
				GER	
KDT 3.60	□	549000 21100	DICHTUNGSSATZ ¹⁾		
	6	000100 21600	GEHÄUSE		
	9	020004 21100	KOLBEN		
	11	901330 00004	SCHIEBER (SATZ) ²⁾		
	15	000801 21100	SEITENDECKEL		
	16	000701 21100	SEITENDECKEL		
	18	001100 21200	LAGERDECKEL A-SEITE		
	19	001000 21100	LAGERDECKEL B-SEITE		
	20	025511 21100	DICHTUNG		
	24	911312 00000	DICHTUNGSSCHLAUCH		
	26	917152 00000	AUSGLEICHSCHEIBE		
	27	906540 00000	WELLENDICHTRING		
28	906612 50000	WÄLZLAGER 3205 2RS C3 TA			
29	906657 00000	WÄLZLAGER NU 205/ZS			
31	511400 10100	SATZ DISTANZSCHEIBEN			
37	945217 00000	SECHSKANTSCHRAUBE			
38	016801 21100	SPANNSCHEIBE			
39	949807 00000	SENKSCHEIBE			
41	945224 00000	SECHSKANTSCHRAUBE			
42	945222 00000	SECHSKANTSCHRAUBE			
45	948742 00000	PASSKERBSTIFT			
47	947736 00000	PASSFEDER			
50	053201 21100	LATERNE			
52	950308 00000	UNTERLEGSCHNEIBE			
53	945337 00000	INNENSECHSKANTSCHRAUBE			
57	949409 00000	UNTERLEGSCHNEIBE			
58	945270 00000	WELLENENDSCHRAUBE			
61	040101 21100	FILTERGEHÄUSE			
62	025501 21100	DICHTUNG			
64	946955 00000	STIFTSCHRAUBE			
65	951003 00000	STIFTSCHRAUBE			
67	964407 00000	SCHALLDÄMPFERROHR			
68	909507 00000	FILTERPATRONE C 1112/2 (1x) ²⁾			
71	009000 27000	ANPRESSFEDER			
72	948750 00000	BLINDNIET			
73	040201 21100	FILTER-DECKEL			
75	025518 21100	DICHTUNG			
76	025516 21100	DICHTUNG			
77	022802 21100	FILTERTRÄGER			
79	945321 00000	INNENSECHSKANTSCHRAUBE			
80	946971 00000	STIFTSCHRAUBE			
81	947504 00000	UNTERLEGSCHNEIBE			
82	947104 00000	SECHSKANTMUTTER			
83	952019 00000	SPANNHÜLSE			
85	025514 21100	DICHTUNG			
86	025515 21100	DICHTUNG			
88	560203 21100	KÜHLER			
91	909510 00000	FILTERPATRONE C 713 (1x) ²⁾			
93	946965 00000	STIFTSCHRAUBE			
94	947105 00000	SECHSKANTMUTTER			
95	949450 00000	U-SCHNEIBE			
97	950304 00000	U-SCHNEIBE			
98	945322 00000	INNENSECHSKANTSCHRAUBE			
103	068801 21100	DECKEL			
104	025513 21100	DICHTUNG			
105	945319 00000	INNENSECHSKANTSCHRAUBE			
110	921500 50000	HANDGRIFF			
121	560204 21100	KÜHLER			
125	025504 21100	DICHTUNG			

W INDEX	Pos.	Bestell Nr.	Beschreibung	DE	
				GER	
	126	025512 21100	DICHTUNG		
	127	025517 21100	DICHTUNG		
	129	945372 00000	INNENSECHSKANTSCHRAUBE		
	130	945328 00000	INNENSECHSKANTSCHRAUBE		
	132	946930 00000	STIFTSCHRAUBE		
	134	005602 21100	DECKEL		
	141	016606 21100	ANSCHLUSS-STÜCK		
	146	025507 21100	DICHTUNG		
	148	945368 00000	INNENSECHSKANTSCHRAUBE		
	149	741310 30000	GUMMIPUFFER		
	161	918300 21100	ABDECKHAUBE		
	163	920800 21100	LUFTLEITHAUBE		
	165	960700 21100	LÜFTERHAUBE		
	166	960701 21100	LÜFTERHAUBE		
	170	945321 00000	INNENSECHSKANTSCHRAUBE		
	171	945371 00000	INNENSECHSKANTSCHRAUBE		
	173	949806 00000	SENKSCHEIBE		
	174	951703 00000	FEDERSCHNEIBE		
	175	741302 00000	GUMMIPUFFER		
	176	945634 00000	GEWINDESTIFT		
	178	951602 00000	RINGMUTTER		
	182	014902 21100	ZWISCHENFLANSCH		
	184	951916 00000	KABELTÜLLE		
	185	948772 00000	ROHRNIETE		
	186	947508 00000	UNTERLEGSCHNEIBE		
	188	945333 00000	INNENSECHSKANTSCHRAUBE		
	190	951018 00000	STIFTSCHRAUBE		
	191	947506 00000	UNTERLEGSCHNEIBE		
	192	947106 00000	SECHSKANTMUTTER		
	195	902108 00000	KUPPLUNGSHÄLFTE (MOT)		
	196	902209 00000	KUPPLUNGSSCHNEIBE / GELB		
	197	544501 21100	GEBLÄSEKUPPLUNG MIT VENTILATOR		
	285	728000 99622	DRUCKREGULIERVENTIL / 0,6 BAR		
	285	728001 99622	DRUCKREGULIERVENTIL / 1,0 BAR		
	285	728002 99622	DRUCKREGULIERVENTIL / 2,0 BAR		
	288	948066 00000	DICHTUNG		
	290	964307 00000	SCHALLDÄMPFERROHR		
	291	912805 00000	VERSCHLUSS-STOPFEN		
		960000 02300	LAGERFETT, AMBLYGON TA15/2 (TUBE, 8g)		



¹⁾ Dichtungssatz - 54900021100 - Pos.: 20, 24, 62, 75, 76, 85, 86, 104, 125, 126, 127, 146, 288
²⁾ erforderliche Bestellmenge / Wartung

W INDEX	Pos.	Ident No.	Description	
KDT 3.60	□	549000 21100	SET OF SEALS ¹⁾	
	6	000100 21600	PUMP BODY	
	9	020004 21100	ROTOR	
	11	901330 00004	CARBON VANES (KIT) ²⁾	
	15	000801 21100	LID	
	16	000701 21100	LID	
	18	001100 21200	BEARING COVER	
	19	001000 21100	BEARING COVER	
	20	025511 21100	GASKET	
	24	911312 00000	SEAL	
	26	917152 00000	COMPENSATING DISC	
	27	906540 00000	SHAFT-SEALING RING	
28	906612 50000	BALL BEARING		
29	906657 00000	BALL BEARING		
31	511400 10100	SET DISTANCE DISC		
37	945217 00000	HEX HEAD SCREW		
38	016801 21100	CLAMPING DISC		
39	949807 00000	SCREW		
41	945224 00000	HEX-HEAD SCREW		
42	945222 00000	HEX-HEAD SCREW		
45	948742 00000	STRAIGHT PIN		
47	947736 00000	KEY		
50	053201 21100	CONNECTION FLANGE		
52	950308 00000	WASHER		
53	945337 00000	SOCKET HEAD SCREW		
57	949409 00000	WASHER		
58	945270 00000	SHAFT END BOLD		
61	040101 21100	FILTER HOUSING		
62	025501 21100	GASKET		
64	946955 00000	STUD		
65	951003 00000	STUD		
67	964407 00000	SILENCER TUBE		
68	909507 00000	FILTER CARTRIDGE C 1112/2 (1x) ²⁾		
71	009000 27000	LEAF SPRING		
72	948750 00000	BLIND RIVET		
73	040201 21100	FILTER-COVER		
75	025518 21100	GASKET		
76	025516 21100	GASKET		
77	022802 21100	FILTER HOLDER		
79	945321 00000	SOCKET HEAD SCREW		
80	946971 00000	STUD		
81	947504 00000	WASHER		
82	947104 00000	HEX.NUT		
83	952019 00000	LOCATING PEG		
85	025514 21100	GASKET		
86	025515 21100	GASKET		
88	560203 21100	COOLER		
91	909510 00000	FILTER CARTRIDGE C 713 (1x) ²⁾		
93	946965 00000	STUD		
94	947105 00000	HEX.NUT		
95	949450 00000	WASHER		
97	950304 00000	WASHER		
98	945322 00000	SOCKET HEAD SCREW		
103	068801 21100	COVER		
104	025513 21100	GASKET		
105	945319 00000	SOCKET HEAD SCREW		
110	921500 50000	HANDLE		
121	560204 21100	COOLER		
125	025504 21100	GASKET		

W INDEX	Pos.	Ident No.	Description	
	126	025512 21100	GASKET	
	127	025517 21100	GASKET	
	129	945372 00000	SOCKET HEAD SCREW	
	130	945328 00000	SOCKET HEAD SCREW	
	132	946930 00000	STUD	
	134	005602 21100	COVER	
	141	016606 21100	CONNECTING PIECE	
	146	025507 21100	GASKET	
	148	945368 00000	SOCKET HEAD SCREW	
	149	741310 30000	RUBBER BUFFER	
	161	918300 21100	COVERING HOOD	
	163	920800 21100	AIR GUIDE HOOD	
	165	960700 21100	VENTILATOR HOOD	
	166	960701 21100	VENTILATOR HOOD	
	170	945321 00000	SOCKET HEAD SCREW	
	171	945371 00000	SOCKET HEAD SCREW	
	173	949806 00000	SCREW	
	174	951703 00000	SPRING DISC	
	175	741302 00000	RUBBER BUFFER	
	176	945634 00000	THREADED PIN	
	178	951602 00000	RING UNIT	
	182	014902 21100	FLANGES	
	184	951916 00000	RUBBER BUSHING	
	185	948772 00000	PIPE RIVET	
	186	947508 00000	WASHER	
	188	945333 00000	SOCKET HEAD SCREW	
	190	951018 00000	STUD	
	191	947506 00000	WASHER	
	192	947106 00000	HEX.NUT	
	195	902108 00000	COUPLING	
	196	902209 00000	COUPLING DISC	
	197	544501 21100	COUPLING WITH FAN	
	285	728000 99622	PRESSURE REGULATING VALVE / 8,7 PSI	
	285	728001 99622	PRESSURE REGULATING VALVE / 14,5 PSI	
	285	728002 99622	PRESSURE REGULATING VALVE / 29 PSI	
	288	948066 00000	SEALING RING	
	290	964307 00000	SILENCER TUBE	
	291	912805 00000	PLUG	
		960000 02300	GREASE, AMBLYGON TA15/2 (TUBE, 8g)	
				

¹⁾ Set of seals - 54900021100 - Pos.: 20, 24, 62, 75, 76, 85, 86, 104, 125, 126, 127, 146, 288
²⁾ necessary order quantity / maintenance

W INDICE	Pos.	No. Identification	Designation	FR	
KDT 3.60	□	549000 21100	JEU DE JOINTS ¹⁾		
	6	000100 21600	CORP DE POMPE		
	9	020004 21100	PISTON		
	11	901330 00004	PALETTE DE CHARBON (KIT) ²⁾		
	15	000801 21100	COUVERCLE		
	16	000701 21100	COUVERCLE		
	18	001100 21200	COUVERCLE DE ROULEMENT		
	19	001000 21100	COUVERCLE DE ROULEMENT		
	20	025511 21100	JOINT		
	24	911312 00000	JOINT		
	26	917152 00000	DISQUE DE COMPENSATION		
	27	906540 00000	BAGUE D'ETANCHEITE P.L'AXE		
	28	906612 50000	ROULEMENT A BILLES		
	29	906657 00000	ROULEMENT A BILLES		
	31	511400 10100	JEU DISQUE DE TOLERANCE		
	37	945217 00000	VIS HEXAGONALE		
	38	016801 21100	DISQUE DE SERRAGE		
	39	949807 00000	VIS		
	41	945224 00000	VIS HEXAGONALE		
	42	945222 00000	VIS HEXAGONALE		
	45	948742 00000	GOUPILLE CYLINDRIQUE		
	47	947736 00000	CLAVETTE		
	50	053201 21100	BRIDE DE RACCORDEMENT		
	52	950308 00000	RONDELLE		
	53	945337 00000	VIS HEXAGONALE INTERNE		
	57	949409 00000	RONDELLE		
	58	945270 00000	VIS BOUT D'ARBRE		
	61	040101 21100	BOITE POUR FILTRE		
	62	025501 21100	JOINT		
	64	946955 00000	TOURILLON		
	65	951003 00000	PRISONNIER		
	67	964407 00000	TUBE SILENCIEUX		
	68	909507 00000	CARTOUCHE FILTRANTE C 1112/2 (1x) ²⁾		
	71	009000 27000	RESSORT-JAME		
	72	948750 00000	RIVET AVEUGLIE		
	73	040201 21100	COUVERCLE DU FILTRE		
	75	025518 21100	JOINT		
	76	025516 21100	JOINT		
	77	022802 21100	SUPPORT FILTRE		
	79	945321 00000	VIS HEXAGONALE INTERNE		
	80	946971 00000	PRISONNIER		
	81	947504 00000	RONDELLE		
	82	947104 00000	ECROU A 6PANS		
	83	952019 00000	DOUILLE DE ETRAGE		
	85	025514 21100	JOINT		
	86	025515 21100	JOINT		
	88	560203 21100	REFROIDISSEUR		
	91	909510 00000	CARTOUCHE FILTRANTE C 713 (1x) ²⁾		
	93	946965 00000	PRISONNIER		
	94	947105 00000	ECROU A 6 PANS		
	95	949450 00000	RONDELLE		
	97	950304 00000	RONDELLE		
	98	945322 00000	VIS HEXAGONALE INTERNE		
	103	068801 21100	COUVERCLE		
	104	025513 21100	JOINT		
	105	945319 00000	VIS HEXAGONALE INTERNE		
	110	921500 50000	POIGNEE		
	121	560204 21100	REFROIDISSEUR		
	125	025504 21100	JOINT		

W INDICE	Pos.	No. Identification	Designation	FR	
	126	025512 21100	JOINT		
	127	025517 21100	JOINT		
	129	945372 00000	VIS HEXAGONALE INTERNE		
	130	945328 00000	VIS HEXAGONALE INTERNE		
	132	946930 00000	PRISONNIER		
	134	005602 21100	COUVERCLE		
	141	016606 21100	PIECE RACCORD		
	146	025507 21100	JOINT		
	148	945368 00000	VIS HEXAGONALE INTERNE		
	149	741310 30000	AMORTISSEUR EN CAOUTCHOUC		
	161	918300 21100	CARTER		
	163	920800 21100	CAPOT DE CANALISATION DE L'AIR		
	165	960700 21100	CARTER DE VENTILATEUR		
	166	960701 21100	CARTER DE VENTILATEUR		
	170	945321 00000	VIS HEXAGONALE INTERNE		
	171	945371 00000	VIS HEXAGONALE INTERNE		
	173	949806 00000	VIS À TÊTE NOYÉE		
	174	951703 00000	DISQUE DE RESSORT		
	175	741302 00000	AMORTISSEUR EN CAOUTCHOUC		
	176	945634 00000	GOUPILLE FILETEE		
	178	951602 00000	ECROU A ANNEAU		
	182	014902 21100	BRIDES		
	184	951916 00000	PROTECTION EN CAOUTCHOUC		
	185	948772 00000	RIVET TUBE		
	186	947508 00000	RONDELLE		
	188	945333 00000	VIS HEXAGONALE INTERNE		
	190	951018 00000	PRISONNIER		
	191	947506 00000	RONDELLE		
	192	947106 00000	ECROU A 6 PANS		
	195	902108 00000	ACCOUPLLEMENT		
	196	902209 00000	DISQUE D'ACCOUPLLEMENT		
	197	544501 21100	ACCOUPLLEMENT AVEC VENTILATEUR		
	285	728000 99622	SOUPAPE REGLAGE PRESSION / 0,6 BAR		
	285	728001 99622	SOUPAPE REGLAGE PRESSION / 1,0 BAR		
	285	728002 99622	SOUPAPE REGLAGE PRESSION / 2,0 BAR		
	288	948066 00000	JOINT		
	290	964307 00000	TUBE SILENCIEUX		
	291	912805 00000	BOUCHON		
		960000 02300	GRAISSE, AMBLYGON TA15/2 (TUBE, 8g)		



¹⁾ Jeu de joints - 54900021100 - Pos.: 20, 24, 62, 75, 76, 85, 86, 104, 125, 126, 127, 146, 288

²⁾ quantité nécessaire / entretien

W INDICE	Pos.	No. Identificazione	Designazione	IT	
KDT 3.60	■	549000 21100	SERIE DI GUARNIZIONE ¹⁾		
	6	000100 21600	CARASSA		
	9	020004 21100	ROTORE		
	11	901330 00004	PALETTE DI CHARBONE (KIT) ²⁾		
	15	000801 21100	COPERCHIO		
	16	000701 21100	COPERCHIO		
	18	001100 21200	COPERCHIO CUSCINETTO		
	19	001000 21100	COPERCHIO CUSCINETTO		
	20	025511 21100	GUARNIZIONE		
	24	911312 00000	GUARNIZIONE		
	26	917152 00000	DISCO COMPENSATORE		
	27	906540 00000	GUARNIZIONE PER L'ALBERO		
	28	906612 50000	CUSCINETTO A SFERA		
	29	906657 00000	CUSCINETTO A SFERA		
	31	511400 10100	SERIE DISCO GIUOCO		
	37	945217 00000	VITE ESAGONALE		
	38	016801 21100	DISCO DI FISSAGIO		
	39	949807 00000	VITE		
	41	945224 00000	VITE ESAGONALE		
	42	945222 00000	VITE ESAGONALE		
	45	948742 00000	PERNO		
	47	947736 00000	CHIAVETTA		
	50	053201 21100	FLANGIA DI RACCORDE		
	52	950308 00000	RONDELLA		
	53	945337 00000	VITE ESAGONALE INTERNA		
	57	949409 00000	RONDELLA		
	58	945270 00000	VITE DI CHIUSURA ALBERO		
	61	040101 21100	CARASSA DEL FILTRO		
	62	025501 21100	GUARNIZIONE		
	64	946955 00000	PRIGIONIERO		
	65	951003 00000	L'ASTA A VITE		
	67	964407 00000	TUBO SILENZIATORE		
	68	909507 00000	CARTUCCIA FILTRO C 1112/2 (1x) ²⁾		
	71	009000 27000	MOLLA		
	72	948750 00000	RIVETTO CIECO		
	73	040201 21100	COPERCHIO FILTRO		
	75	025518 21100	GUARNIZIONI		
	76	025516 21100	GUARNIZIONE		
	77	022802 21100	SUPPORTO FILTRO		
	79	945321 00000	VITE ESAGONALE INTERNA		
	80	946971 00000	L'ASTA A VITE		
	81	947504 00000	RONDELLA		
	82	947104 00000	DADO ESAGONALE		
	83	952019 00000	SPINE DI RISCONTRO		
	85	025514 21100	GUARNIZIONE		
	86	025515 21100	GUARNIZIONE		
	88	560203 21100	RAFFREDDATORE		
	91	909510 00000	CARTUCCIA FILTRO C 713 (1x) ²⁾		
	93	946965 00000	L'ASTA A VITE		
	94	947105 00000	DADO ESAGONALE		
	95	949450 00000	RONDELLA		
	97	950304 00000	RONDELLA		
	98	945322 00000	VITE ESAGONALE INTERNA		
	103	068801 21100	COPERCHIO		
	104	025513 21100	GUARNIZIONE		
	105	945319 00000	VITE ESAGONALE INTERNA		
	110	921500 50000	MANETTA		
	121	560204 21100	RAFFREDDATORE		
	125	025504 21100	GUARNIZIONE		

W INDICE	Pos.	No. Identificazione	Designazione	IT	
	126	025512 21100	GUARNIZIONE		
	127	025517 21100	GUARNIZIONI		
	129	945372 00000	VITE ESAGONALE INTERNA		
	130	945328 00000	VITE ESAGONALE INTERNA		
	132	946930 00000	L'ASTA A VITE		
	134	005602 21100	COPERCHIO		
	141	016606 21100	PEZZI RACCORDI		
	146	025507 21100	GUARNIZIONE		
	148	945368 00000	VITE ESAGONALE INTERNA		
	149	741310 30000	AMMORTIZZATORE IN GOMMA		
	161	918300 21100	CARTER		
	163	920800 21100	CAPPOTTA DEL CONDOTTA ARIA		
	165	960700 21100	CAPPOTTA DEL VENTILATORE		
	166	960701 21100	CAPPOTTA DEL VENTILATORE		
	170	945321 00000	VITE ESAGONALE INTERNA		
	171	945371 00000	VITE ESAGONALE INTERNA		
	173	949806 00000	VITE A TESTA SVASATA		
	174	951703 00000	DISCO A MOLLA		
	175	741302 00000	AMMORTIZZATORE IN GOMMA		
	176	945634 00000	SPINA FILETTATURA		
	178	951602 00000	GOLFARE CON FORO FILETTATO		
	182	014902 21100	FLANGE		
	184	951916 00000	PROTEZIONE IN GOMMA		
	185	948772 00000	CHiodo TUBOLARE		
	186	947508 00000	RONDELLA		
	188	945333 00000	VITE ESAGONALE INTERNA		
	190	951018 00000	L'ASTA A VITE		
	191	947506 00000	RONDELLA		
	192	947106 00000	DADO ESAGONALE		
	195	902108 00000	GIUNTO		
	196	902209 00000	DISCO GIUNTO		
	197	544501 21100	GIUNTO CON VENTILATORE		
	285	728000 99622	VALVOLA REGOLAZ.PRESSIONE / 0,6 BAR		
	285	728001 99622	VALVOLA REGOLAZ.PRESSIONE / 1,0 BAR		
	285	728002 99622	VALVOLA REGOLAZ.PRESSIONE / 2,0 BAR		
	288	948066 00000	ANELLO GUARNIZIONE		
	290	964307 00000	TUBO SILENZIATORE		
	291	912805 00000	TAPPO DI CHIUSURA		
		960000 02300	GRASSO, AMBLYGON TA15/2 (TUBETTO, 8g)		



¹⁾ Serie di guarnizione - 54900021100 - Pos.: 20, 24, 62, 75, 76, 85, 86, 104, 125, 126, 127, 146, 288
²⁾ quantità di ordinazione necessari / manutenzione

W INDICE	Pos.	No. De pedido	Descripción	ES	
				ES	
KDT 3.60	■	549000 21100	JUNTA COMPLETA ¹⁾		
	6	000100 21600	CARCASA		
	9	020004 21100	ÉMBOLO		
	11	901330 00004	EMPUJADOR (KIT) ²⁾		
	15	000801 21100	TAPA LATERAL		
	16	000701 21100	TAPA LATERAL		
	18	001100 21200	TAPA DE COJINETE LADO A		
	19	001000 21100	TAPA DE COJINETE LADO B		
	20	025511 21100	JUNTA		
	24	911312 00000	MANGUERA DE JUNTA		
	26	917152 00000	ARANDELA DE COMPENSACIÓN		
	27	906540 00000	ANILLO DE JUNTA DE ÁRBOL		
	28	906612 50000	COJINETE DE RODAMIENTO 3205 2RS C3 TA		
	29	906657 00000	COJINETE DE RODAMIENTO NU 205/ZS		
	31	511400 10100	JUEGO DE ARANDELAS DISTANCIADORAS		
	37	945217 00000	TORNILLO DE CABEZA HEXAGONAL		
	38	016801 21100	ARANDELA TENSORA		
	39	949807 00000	TORNILLO AVELLANADO		
	41	945224 00000	TORNILLO DE CABEZA HEXAGONAL		
	42	945222 00000	TORNILLO DE CABEZA HEXAGONAL		
	45	948742 00000	PASADOR ENTALLADO DE AJUSTE		
	47	947736 00000	LENGÜETA DE AJUSTE		
	50	053201 21100	FAROL		
	52	950308 00000	ARANDELA		
	53	945337 00000	TORNILLO HEXAGONAL INTERIOR		
	57	949409 00000	ARANDELA		
	58	945270 00000	TORNILLO TERMINAL DE ÁRBOL		
	61	040101 21100	CARCASA DE FILTRO		
	62	025501 21100	JUNTA		
	64	946955 00000	ESPÁRRAGO		
	65	951003 00000	ESPÁRRAGO		
	67	964407 00000	TUBO DE SILENCIADOR		
	68	909507 00000	CARTUCHO DE FILTRO C 1112/2 (1x) ²⁾		
	71	009000 27000	MUELLE DE PRESIÓN		
	72	948750 00000	REMACHE CIEGO		
	73	040201 21100	TAPA DE FILTRO		
	75	025518 21100	JUNTA		
	76	025516 21100	JUNTA		
	77	022802 21100	SOPORTE DE FILTRO		
	79	945321 00000	TORNILLO HEXAGONAL INTERIOR		
	80	946971 00000	ESPÁRRAGO		
	81	947504 00000	ARANDELA		
	82	947104 00000	TUERCA HEXAGONAL		
	83	952019 00000	CASQUILLO TENSOR		
	85	025514 21100	JUNTA		
	86	025515 21100	JUNTA		
	88	560203 21100	REFRIGERADOR		
	91	909510 00000	CARTUCHO DE FILTRO C 713 (1x) ²⁾		
	93	946965 00000	ESPÁRRAGO		
	94	947105 00000	TUERCA HEXAGONAL		
	95	949450 00000	ARANDELA		
	97	950304 00000	ARANDELA		
	98	945322 00000	TORNILLO HEXAGONAL INTERIOR		
	103	068801 21100	TAPA		
	104	025513 21100	JUNTA		
	105	945319 00000	TORNILLO HEXAGONAL INTERIOR		
	110	921500 50000	EMPUÑADURA		
	121	560204 21100	REFRIGERADOR		
	125	025504 21100	JUNTA		

W INDICE	Pos.	No. De pedido	Descripción	ES	
				ES	
	126	025512 21100	JUNTA		
	127	025517 21100	JUNTA		
	129	945372 00000	TORNILLO HEXAGONAL INTERIOR		
	130	945328 00000	TORNILLO HEXAGONAL INTERIOR		
	132	946930 00000	ESPÁRRAGO		
	134	005602 21100	TAPA		
	141	016606 21100	PIEZA DE EMPALME		
	146	025507 21100	JUNTA		
	148	945368 00000	TORNILLO HEXAGONAL INTERIOR		
	149	741310 30000	AMORTIGUADOR DE GOMA		
	161	918300 21100	CAPERUZA DE RECUBRIMIENTO		
	163	920800 21100	CAPERUZA CONDUCTOR DE AIRE		
	165	960700 21100	CAPERUZA DE VENTILADOR		
	166	960701 21100	CAPERUZA DE VENTILADOR		
	170	945321 00000	TORNILLO HEXAGONAL INTERIOR		
	171	945371 00000	TORNILLO HEXAGONAL INTERIOR		
	173	949806 00000	TORNILLO AVELLANADO		
	174	951703 00000	ARANDELA ELÁSTICA		
	175	741302 00000	AMORTIGUADOR DE GOMA		
	176	945634 00000	VARILLA ROSCADA		
	178	951602 00000	TUERCA DE CÁNCAMO		
	182	014902 21100	BRIDA INTERMEDIA		
	184	951916 00000	BOQUILLA DE CABLE		
	185	948772 00000	REMACHE TUBULAR		
	186	947508 00000	ARANDELA		
	188	945333 00000	TORNILLO HEXAGONAL INTERIOR		
	190	951018 00000	ESPÁRRAGO		
	191	947506 00000	ARANDELA		
	192	947106 00000	TUERCA HEXAGONAL		
	195	902108 00000	MITAD DE ACOPLAMIENTO (MOT)		
	196	902209 00000	DISCO DE ACOPLAMIENTO / AMARILLO		
	197	544501 21100	ACOPLAMIENTO DE SOPLADO CON VÁLVULA		
	285	728000 99622	VÁLVULA REGULADORA DE PRESIÓN / 0,6 BAR		
	285	728001 99622	VÁLVULA REGULADORA DE PRESIÓN / 1,0 BAR		
	285	728002 99622	VÁLVULA REGULADORA DE PRESIÓN / 2,0 BAR		
	288	948066 00000	ANILLO DE JUNTA		
	290	964307 00000	TUBO DE SILENCIADOR		
	291	912805 00000	TAPÓN DE DESGASTE		
		960000 02300	GRASA, AMBLYGON TA15/2 (TUBO, 8g)		





¹⁾ Junta completa - 54900021100 - Pos.: 20, 24, 62, 75, 76, 85, 86, 104, 125, 126, 127, 146, 288

²⁾ cantidad necesario / mantenimiento

KDT 3.60	Variante 	Pos. ²⁾	Bestell Nr. / Ident No. / No. Identification / No. Identificazione / No. De pedido		Beschreibung / Description / Designation / Designazione / Desripcion
① US-motor		190		951018-00000	STIFTSCHRAUBE / STUD / PRISONNIER / L'ASTA A VITE / ESPÁRRAGO
		191		947506-00000	UNTERLEGSCHIEBE / WASHER / RONDELLE / RONDELLA / ARANDELA
		192		947106-00000	SECHSKANTMUTTER / HEX.NUT / ECROU A 6 PANS / DADO ESAGONALE / TUERCA HEXAGONAL
		195	902100 21100	902108-00000	MOTORKUPPLUNG / COUPLING / ACCOUPLEMENT / GIUNTO / ACOPLAMIENTO
② /0-05 - Korrosionsschutz - corrosion protection - protection contre la corrosion - protezione anti-corrosione - protección contra la corrosión		9	020005 21100	020004-21100	KOLBEN / ROTOR / PISTON / ROTORE / ÉMBOLO
③ /6 - Korrosionsschutz - corrosion protection - protection contre la corrosion - protezione anti-corrosione - protección contra la corrosión		6	000110 21600	000100-21600	GEHÄUSE / PUMP BODY / CORP DE POMPE / CARCASSA / CARCASA
		9	020011 21100	020004-21100	KOLBEN / ROTOR / PISTON / ROTORE / ÉMBOLO
		11	901379 00004	901330-00004	SATZ (KIT) SCHIEBER / VANES / PALETTE / PALETTE / EMPUJADOR
		15	000811 21100	000801-21100	SEITENDECKEL / LID LATERAL / COUVERCLE LATÉRAL / COPERCHIO LATERALE / TAPA LATERAL
		16	000711 21100	000701-21100	SEITENDECKEL / LID LATERAL / COUVERCLE LATÉRAL / COPERCHIO LATERALE / TAPA LATERAL
		68	909587 00000	909507-00000	FILTERPATRONE / FILTER CARTRIDGE / CARTOUCHE FILTRE / CARTUCCIA FILTRO / CARTUCHO DE FILTRO
④ /6-29 - Korrosionsschutz - corrosion protection - protection contre la corrosion - protezione anti-corrosione - protección contra la corrosión		6	000110 21600	000100-21600	GEHÄUSE / PUMP BODY / CORP DE POMPE / CARCASSA / CARCASA
		9	020012 21100	020004-21100	KOLBEN / ROTOR / PISTON / ROTORE / ÉMBOLO
		11	901379 00007	901330-00004	SATZ (KIT) SCHIEBER / VANES / PALETTE / PALETTE / EMPUJADOR
		15	000811 21100	000801-21100	SEITENDECKEL / LID LATERAL / COUVERCLE LATÉRAL / COPERCHIO LATERALE / TAPA LATERAL
		16	000711 21100	000701-21100	SEITENDECKEL / LID LATERAL / COUVERCLE LATÉRAL / COPERCHIO LATERALE / TAPA LATERAL
		68	909587 00000	909507-00000	FILTERPATRONE / FILTER CARTRIDGE / CARTOUCHE FILTRE / CARTUCCIA FILTRO / CARTUCHO DE FILTRO
⑤ /0-52 - Korrosionsschutz - corrosion protection - protection contre la corrosion - protezione anti-corrosione - protección contra la corrosión		9	020005 21100	020004-21100	KOLBEN / ROTOR / PISTON / ROTORE / ÉMBOLO
		11	901379 00004	901330-00004	SATZ (KIT) SCHIEBER / VANES / PALETTE / PALETTE / EMPUJADOR
		285		72800X-99622	DRUCKREGULIERVENTIL / PRESSURE REGULATING VALVE / SOUPAPE REGLAGE PRESSION / VALVOLA REGOLAZIONE PRESSIONE / VÁLVULA REGULADORA DE PRESIÓN
		403	734000 02000		DRUCKREGULIERVENTIL 2,2 BAR / PRESSURE REGULATING VALVE 32 PSI / SOUPAPE REGLAGE PRESSION 2,2 BAR / VALVOLA REGOLAZIONE PRESSIONE 2,2 BAR / VÁLVULA REGULADORA DE PRESIÓN 2,2 BAR
⑥ /0-54 - Kühlung - refrigeration - réfrigération - refrigerazione - refrigeración		88		560203-21100	KÜHLER / COOLER / REFROIDISSEUR / RAFFREDDATORE / REFRIGERADOR
		166		960701-21100	LÜFTERHAUBE / VENTILATOR HOOD / CARTER DE VENTILATEUR / CAPPOTTA DEL VENTILATORE / CAPERUZA DE VENTILADOR
		210	560700 21100		LÜFTERHAUBE / VENTILATOR HOOD / CARTER DE VENTILATEUR / CAPPOTTA DEL VENTILATORE / CAPERUZA DE VENTILADOR
		230	019901 21100		UMLENKSTÜCK / RETURN PIECE / PIECE DE RETOUR / PEZZO INVERSIONE / PIEZA DE DESVIACIÓN

²⁾ variantenabhängige Bauteile / variant-dependent components / composants variante-dependantes / componenti variante-dispendenti / componentes variante-dependientes

KDT 3.60	Variante 	Pos. ²⁾	Bestell Nr. / Ident No. / No. Identification / No. Identificazione / No. De pedido		Beschreibung / Description / Designation / Designazione / Desripcion
					
⑦ /B5/200 - Motoranschluß - motor flange - bride de moteur - flangia del motore - brida de motor		182	014900 21600	014900 21100	ZWISCHENFLANSCH / INTERMEDIATE FLANGE / BRIDE INTERMEDIAIRE / FLANGE INTERMEDIA / BRIDA INTERMEDIA
		195	902100 21600	902100 00000	MOTORKUPPLUNG / COUPLING / ACCOUPLEMENT / GIUNTO / ACOPLAMIENTO

²⁾ variantenabhängige Bauteile / variant-dependent components / composants variante-dependantes / componenti variante-dispendenti / componentes variante-dependientes