

# KDT 3.60

**Ersatzteilliste**  
**Spare parts list**  
**Liste de pièces de rechange**  
**Listino pezzi di ricambio**  
**Lista de piezas de recambio**  
**Reserveonderdelenlijst**  
**Reservedelsliste**  
**Reservdelislista**

**Reservedelsliste**  
**Varaosaluettelo**  
**Wykaz części zamiennych**  
**Seznam náhradních dílů**  
**Tartalékalkatrész lista**  
**Κατάλογος ανταλλακτικών**  
**Перечень запасных частей**  
**备用零件目录**  
**スペアパーツリスト**

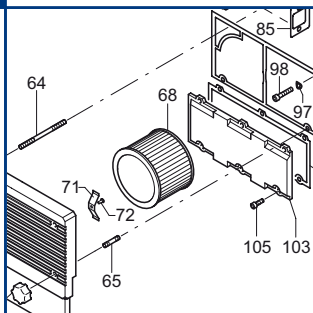

**SERVICE**

**BECKER**  
D-42279 Wuppertal  
www.becker-international.com

year: XXXX

No. **D** → **Index Variante**

type: **KDT 3.60-XX**

frequency: XXXX Hz

speed: XXXX min<sup>-1</sup>

power required: XXXX kW

inlet capacity: XXXX m<sup>3</sup>/h

pressure: XXXX mbar

vacuum: XXXX mbar

Made in  Germany

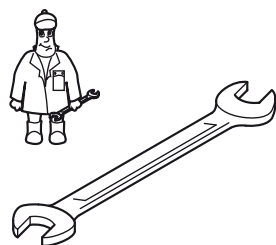

Pos.	Menge <sup>2)</sup> Quantity Quantité Quantità Cantidad	Bestell-Nr. Ident No. No. Identification No. Identificazione No. de pedido	Bezeichnung Description Designation Designazione Descripción
□	1	549000 21100	Dichtungssatz, Complete set of seals, Jeu de joints, Kit di guarnizioni, Junta Completa
11	SATZ/KIT	901330 00004	Schieber, Rotor Vane, Palette, Empujador
11		901379 00004	„ KDT 3.60/0-52
11		901379 00004	„ KDT 3.60/6
11		901401 00007	„ KDT 3.60/0-29
11		901379 00007	„ KDT 3.60/6-29
68	1	909507 00000	Filterpatrone, Filter cartridge, Cartouche Filtrante, Cartuccia filtro, Cartucho de filtro
68	1	909587 00000	„ KDT 3.60/6
91	1	909510 00000	Filterpatrone, Filter cartridge, Cartouche Filtrante, Cartuccia filtro, Cartucho de filtro

<sup>2)</sup> erforderliche Bestellmenge / necessary order quantity / quantité nécessaire / quantità di ordinazione necessari / cantidad necesario

**Wartung**  
**Maintenance**  
**Entretien**  
**Manutenzione**  
**Mantenimiento**



# SERVICE

[www.becker-international.com](http://www.becker-international.com)

Sales and service network

KDT 3.60 Standard



Variante



KDT 3.60/XX

①  
US-motor

- ②-⑤  
/0-05, /6, 6-29, /0-52  
- Korrosionsschutz  
- corrosion protection  
- protection contre la corrosion  
- protezione anti-corrosione  
- protección contra la corrosión

- ⑥  
/0-54  
- Kühlung  
- refrigeration  
- réfrigération  
- refrigerazione  
- refrigeración

⑦  
B5-200

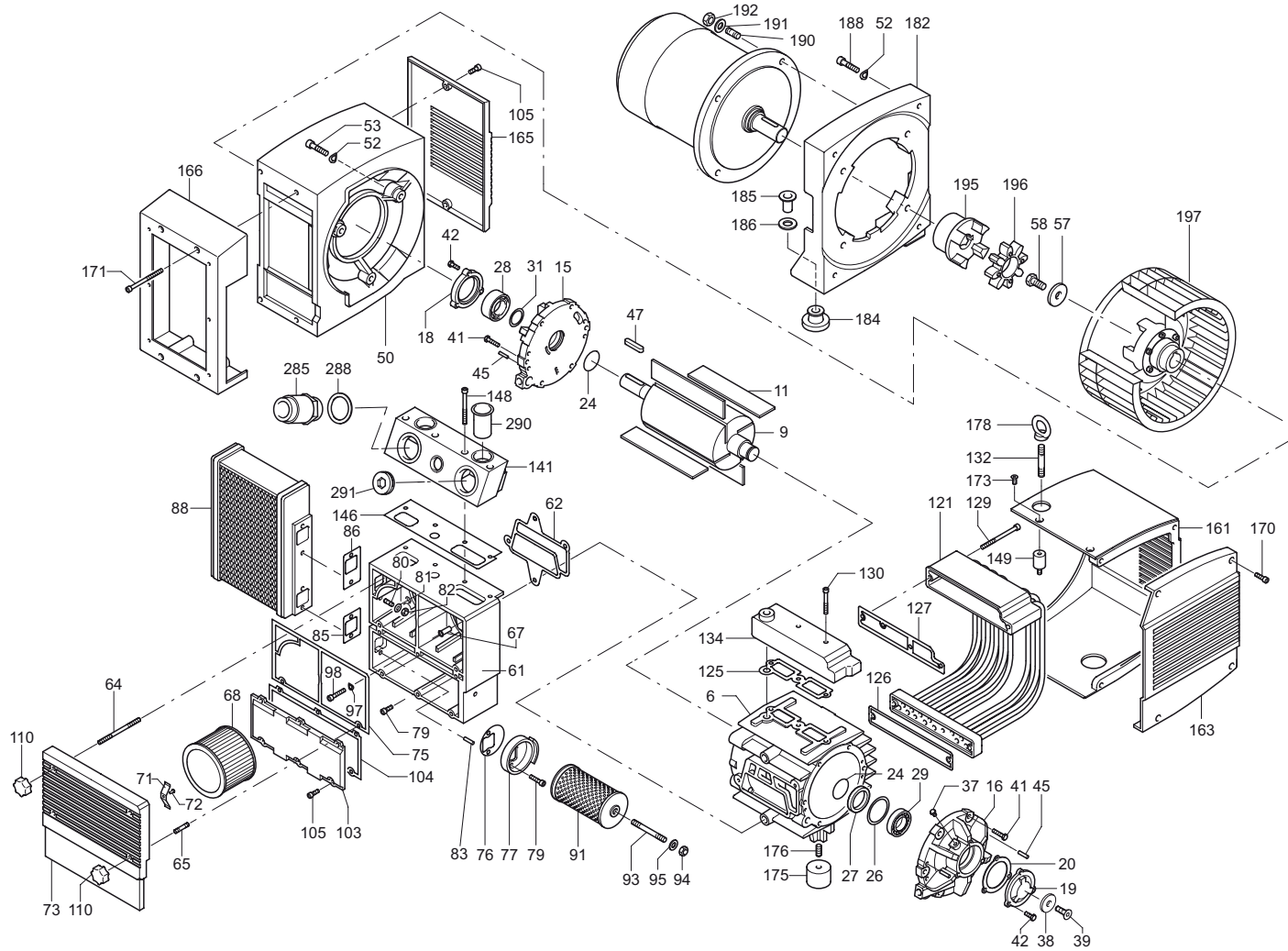

SERVICE ?

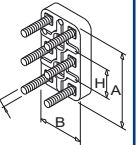
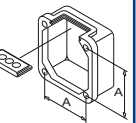
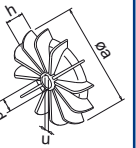
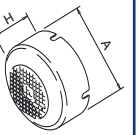



D INDEX	Pos.	Bestell Nr.	Beschreibung	DE	
				GER	
KDT 3.60	□	549000 21100	DICHTUNGSSATZ <sup>1)</sup>		
	6	000100 21600	GEHÄUSE		
	9	020004 21100	KOLBEN		
	11	901330 00004	SCHIEBER (SATZ) <sup>2)</sup>		
	15	000801 21100	SEITENDECKEL		
	16	000701 21100	SEITENDECKEL		
	18	001100 21200	LAGERDECKEL A-SEITE		
	19	001000 21100	LAGERDECKEL B-SEITE		
	20	025511 21100	DICHTUNG		
	24	911312 00000	DICHTUNGSSCHLAUCH		
	26	917152 00000	AUSGLEICHSCHEIBE		
	27	906540 00000	WELLENDICHTRING		
	28	906612 50000	WÄLZLAGER 3205 2RS C3 TA		
	29	906657 00000	WÄLZLAGER NU 205/ZS		
	31	511400 10100	SATZ DISTANZSCHEIBEN		
	37	945217 00000	SECHSKANTSCHRAUBE		
	38	016801 21100	SPANNSCHEIBE		
	39	949807 00000	SENKSCHEIBE		
	41	945224 00000	SECHSKANTSCHRAUBE		
	42	945222 00000	SECHSKANTSCHRAUBE		
	45	948742 00000	PASSKERBSTIFT		
	47	947736 00000	PASSFEDER		
	50	053201 21100	LATERNE		
	52	950308 00000	UNTERLEGSCHNEIBE		
	53	945337 00000	INNENSECHSKANTSCHRAUBE		
	57	949409 00000	UNTERLEGSCHNEIBE		
	58	945270 00000	WELLENENDSCHRAUBE		
	61	040101 21100	FILTERGEHÄUSE		
	62	025501 21100	DICHTUNG		
	64	946955 00000	STIFTSCHRAUBE		
	65	951003 00000	STIFTSCHRAUBE		
	67	964407 00000	SCHALLDÄMPFERROHR		
	68	909507 00000	FILTERPATRONE C 1112/2 (1x) <sup>2)</sup>		
	71	009000 27000	ANPRESSFEDER		
	72	948750 00000	BLINDNIET		
	73	040201 21100	FILTER-DECKEL		
	75	025518 21100	DICHTUNG		
	76	025516 21100	DICHTUNG		
	77	022802 21100	FILTERTRÄGER		
	79	945321 00000	INNENSECHSKANTSCHRAUBE		
	80	946971 00000	STIFTSCHRAUBE		
	81	947504 00000	UNTERLEGSCHNEIBE		
	82	947104 00000	SECHSKANTMUTTER		
	83	952019 00000	SPANNHÜLSE		
	85	025514 21100	DICHTUNG		
	86	025515 21100	DICHTUNG		
	88	560203 21100	KÜHLER		
	91	909510 00000	FILTERPATRONE C 713 (1x) <sup>2)</sup>		
	93	946965 00000	STIFTSCHRAUBE		
	94	947105 00000	SECHSKANTMUTTER		
	95	949450 00000	U-SCHNEIBE		
	97	950304 00000	U-SCHNEIBE		
	98	945322 00000	INNENSECHSKANTSCHRAUBE		
	103	068801 21100	DECKEL		
	104	025513 21100	DICHTUNG		
	105	945319 00000	INNENSECHSKANTSCHRAUBE		
	110	921500 50000	HANDGRIFF		
	121	560204 21100	KÜHLER		
	125	025504 21100	DICHTUNG		

D INDEX	Pos.	Bestell Nr.	Beschreibung	DE	
				GER	
	126	025512 21100	DICHTUNG		
	127	025517 21100	DICHTUNG		
	129	945372 00000	INNENSECHSKANTSCHRAUBE		
	130	945328 00000	INNENSECHSKANTSCHRAUBE		
	132	946930 00000	STIFTSCHRAUBE		
	134	005602 21100	DECKEL		
	141	016606 21100	ANSCHLUSS-STÜCK		
	146	025507 21100	DICHTUNG		
	148	945368 00000	INNENSECHSKANTSCHRAUBE		
	149	741310 30000	GUMMIPUFFER		
	161	918300 21100	ABDECKHAUBE		
	163	920800 21100	LUFTLEITHAUBE		
	165	960700 21100	LÜFTERHAUBE		
	166	960701 21100	LÜFTERHAUBE		
	170	945321 00000	INNENSECHSKANTSCHRAUBE		
	171	945371 00000	INNENSECHSKANTSCHRAUBE		
	173	949806 00000	SENKSCHEIBE		
	174	951703 00000	FEDERSCHNEIBE		
	175	741302 00000	GUMMIPUFFER		
	176	945634 00000	GEWINDESTIFT		
	178	951602 00000	RINGMUTTER		
	182	014902 21100	ZWISCHENFLANSCH		
	184	951916 00000	KABELTÜLLE		
	185	948772 00000	ROHRNIETE		
	186	947508 00000	UNTERLEGSCHNEIBE		
	188	945333 00000	INNENSECHSKANTSCHRAUBE		
	190	951018 00000	STIFTSCHRAUBE		
	191	947506 00000	UNTERLEGSCHNEIBE		
	192	947106 00000	SECHSKANTMUTTER		
	195	902108 00000	KUPPLUNGSHÄLFTE (MOT)		
	196	902209 00000	KUPPLUNGSSCHNEIBE / GELB		
	197	544501 21100	GEBLÄSEKUPPLUNG MIT VENTILATOR		
	285	728000 99622	DRUCKREGULIERVENTIL / 0,6 BAR		
	285	728001 99622	DRUCKREGULIERVENTIL / 1,0 BAR		
	285	728002 99622	DRUCKREGULIERVENTIL / 2,0 BAR		
	288	948066 00000	DICHTUNG		
	290	964307 00000	SCHALLDÄMPFERROHR		
	291	912805 00000	VERSCHLUSS-STOPFEN		
		960000 02300	LAGERFETT, AMBLYGON TA15/2 (TUBE, 8g)		



<sup>1)</sup> Dichtungssatz - 54900021100 - Pos.: 20, 24, 62, 75, 76, 85, 86, 104, 125, 126, 127, 146, 288  
<sup>2)</sup> erforderliche Bestellmenge / Wartung

D INDEX	Pos.	Ident No.	Description	
KDT 3.60	□	549000 21100	SET OF SEALS <sup>1)</sup>	
	6	000100 21600	PUMP BODY	
	9	020004 21100	ROTOR	
	11	901330 00004	CARBON VANES (KIT) <sup>2)</sup>	
	15	000801 21100	LID	
	16	000701 21100	LID	
	18	001100 21200	BEARING COVER	
	19	001000 21100	BEARING COVER	
	20	025511 21100	GASKET	
	24	911312 00000	SEAL	
	26	917152 00000	COMPENSATING DISC	
	27	906540 00000	SHAFT-SEALING RING	
28	906612 50000	BALL BEARING		
29	906657 00000	BALL BEARING		
31	511400 10100	SET DISTANCE DISC		
37	945217 00000	HEX HEAD SCREW		
38	016801 21100	CLAMPING DISC		
39	949807 00000	SCREW		
41	945224 00000	HEX-HEAD SCREW		
42	945222 00000	HEX-HEAD SCREW		
45	948742 00000	STRAIGHT PIN		
47	947736 00000	KEY		
50	053201 21100	CONNECTION FLANGE		
52	950308 00000	WASHER		
53	945337 00000	SOCKET HEAD SCREW		
57	949409 00000	WASHER		
58	945270 00000	SHAFT END BOLD		
61	040101 21100	FILTER HOUSING		
62	025501 21100	GASKET		
64	946955 00000	STUD		
65	951003 00000	STUD		
67	964407 00000	SILENCER TUBE		
68	909507 00000	FILTER CARTRIDGE C 1112/2 (1x) <sup>2)</sup>		
71	009000 27000	LEAF SPRING		
72	948750 00000	BLIND RIVET		
73	040201 21100	FILTER-COVER		
75	025518 21100	GASKET		
76	025516 21100	GASKET		
77	022802 21100	FILTER HOLDER		
79	945321 00000	SOCKET HEAD SCREW		
80	946971 00000	STUD		
81	947504 00000	WASHER		
82	947104 00000	HEX.NUT		
83	952019 00000	LOCATING PEG		
85	025514 21100	GASKET		
86	025515 21100	GASKET		
88	560203 21100	COOLER		
91	909510 00000	FILTER CARTRIDGE C 713 (1x) <sup>2)</sup>		
93	946965 00000	STUD		
94	947105 00000	HEX.NUT		
95	949450 00000	WASHER		
97	950304 00000	WASHER		
98	945322 00000	SOCKET HEAD SCREW		
103	068801 21100	COVER		
104	025513 21100	GASKET		
105	945319 00000	SOCKET HEAD SCREW		
110	921500 50000	HANDLE		
121	560204 21100	COOLER		
125	025504 21100	GASKET		

D INDEX	Pos.	Ident No.	Description	
	126	025512 21100	GASKET	
	127	025517 21100	GASKET	
	129	945372 00000	SOCKET HEAD SCREW	
	130	945328 00000	SOCKET HEAD SCREW	
	132	946930 00000	STUD	
	134	005602 21100	COVER	
	141	016606 21100	CONNECTING PIECE	
	146	025507 21100	GASKET	
	148	945368 00000	SOCKET HEAD SCREW	
	149	741310 30000	RUBBER BUFFER	
	161	918300 21100	COVERING HOOD	
	163	920800 21100	AIR GUIDE HOOD	
	165	960700 21100	VENTILATOR HOOD	
	166	960701 21100	VENTILATOR HOOD	
	170	945321 00000	SOCKET HEAD SCREW	
	171	945371 00000	SOCKET HEAD SCREW	
	173	949806 00000	SCREW	
	174	951703 00000	SPRING DISC	
	175	741302 00000	RUBBER BUFFER	
	176	945634 00000	THREADED PIN	
	178	951602 00000	RING UNIT	
	182	014902 21100	FLANGES	
	184	951916 00000	RUBBER BUSHING	
	185	948772 00000	PIPE RIVET	
	186	947508 00000	WASHER	
	188	945333 00000	SOCKET HEAD SCREW	
	190	951018 00000	STUD	
	191	947506 00000	WASHER	
	192	947106 00000	HEX.NUT	
	195	902108 00000	COUPLING	
	196	902209 00000	COUPLING DISC	
	197	544501 21100	COUPLING WITH FAN	
	285	728000 99622	PRESSURE REGULATING VALVE / 8,7 PSI	
	285	728001 99622	PRESSURE REGULATING VALVE / 14,5 PSI	
	285	728002 99622	PRESSURE REGULATING VALVE / 29 PSI	
	288	948066 00000	SEALING RING	
	290	964307 00000	SILENCER TUBE	
	291	912805 00000	PLUG	
		960000 02300	GREASE, AMBLYGON TA15/2 (TUBE, 8g)	
				

<sup>1)</sup> Set of seals - 54900021100 - Pos.: 20, 24, 62, 75, 76, 85, 86, 104, 125, 126, 127, 146, 288  
<sup>2)</sup> necessary order quantity / maintenance

D INDICE	Pos.	No. Identification	Designation	FR	
KDT 3.60	□	549000 21100	JEU DE JOINTS <sup>1)</sup>		
	6	000100 21600	CORP DE POMPE		
	9	020004 21100	PISTON		
	11	901330 00004	PALETTE DE CHARBON (KIT) <sup>2)</sup>		
	15	000801 21100	COUVERCLE		
	16	000701 21100	COUVERCLE		
	18	001100 21200	COUVERCLE DE ROULEMENTE		
	19	001000 21100	COUVERCLE DE ROULEMENTE		
	20	025511 21100	JOINT		
	24	911312 00000	JOINT		
	26	917152 00000	DISQUE DE COMPENSATION		
	27	906540 00000	BAGUE D'ETANCHEITE P.L'AXE		
	28	906612 50000	ROULEMENT A BILLES		
	29	906657 00000	ROULEMENT A BILLES		
	31	511400 10100	JEU DISQUE DE TOLERANCE		
	37	945217 00000	VIS HEXAGONALE		
	38	016801 21100	DISQUE DE SERRAGE		
	39	949807 00000	VIS		
	41	945224 00000	VIS HEXAGONALE		
	42	945222 00000	VIS HEXAGONALE		
	45	948742 00000	GOUPILLE CYLINDRIQUE		
	47	947736 00000	CLAVETTE		
	50	053201 21100	BRIDE DE RACCORDEMENT		
	52	950308 00000	RONDELLE		
	53	945337 00000	VIS HEXAGONALE INTERNE		
	57	949409 00000	RONDELLE		
	58	945270 00000	VIS BOUT D'ARBRE		
	61	040101 21100	BOITE POUR FILTRE		
	62	025501 21100	JOINT		
	64	946955 00000	TOURILLON		
	65	951003 00000	PRISONNIER		
	67	964407 00000	TUBE SILENCIEUX		
	68	909507 00000	<b>CARTOUCHE FILTRANTE C 1112/2 (1x) <sup>2)</sup></b>		
	71	009000 27000	RESSORT-JAME		
	72	948750 00000	RIVET AVEUGLIE		
	73	040201 21100	COUVERCLE DU FILTRE		
	75	025518 21100	JOINT		
	76	025516 21100	JOINT		
	77	022802 21100	SUPPORT FILTRE		
	79	945321 00000	VIS HEXAGONALE INTERNE		
	80	946971 00000	PRISONNIER		
	81	947504 00000	RONDELLE		
	82	947104 00000	ECROU A 6PANS		
	83	952019 00000	DOUILLE DE ETRAGE		
	85	025514 21100	JOINT		
	86	025515 21100	JOINT		
	88	560203 21100	REFROIDISSEUR		
	91	909510 00000	<b>CARTOUCHE FILTRANTE C 713 (1x) <sup>2)</sup></b>		
	93	946965 00000	PRISONNIER		
	94	947105 00000	ECROU A 6 PANS		
	95	949450 00000	RONDELLE		
	97	950304 00000	RONDELLE		
	98	945322 00000	VIS HEXAGONALE INTERNE		
	103	068801 21100	COUVERCLE		
	104	025513 21100	JOINT		
	105	945319 00000	VIS HEXAGONALE INTERNE		
	110	921500 50000	POIGNEE		
	121	560204 21100	REFROIDISSEUR		
	125	025504 21100	JOINT		

D INDICE	Pos.	No. Identification	Designation	FR	
	126	025512 21100	JOINT		
	127	025517 21100	JOINT		
	129	945372 00000	VIS HEXAGONALE INTERNE		
	130	945328 00000	VIS HEXAGONALE INTERNE		
	132	946930 00000	PRISONNIER		
	134	005602 21100	COUVERCLE		
	141	016606 21100	PIECE RACCORD		
	146	025507 21100	JOINT		
	148	945368 00000	VIS HEXAGONALE INTERNE		
	149	741310 30000	AMORTISSEUR EN CAOUTCHOUC		
	161	918300 21100	CARTER		
	163	920800 21100	CAPOT DE CANALISATION DE L'AIR		
	165	960700 21100	CARTER DE VENTILATEUR		
	166	960701 21100	CARTER DE VENTILATEUR		
	170	945321 00000	VIS HEXAGONALE INTERNE		
	171	945371 00000	VIS HEXAGONALE INTERNE		
	173	949806 00000	VIS À TÊTE NOYÉE		
	174	951703 00000	DISQUE DE RESSORT		
	175	741302 00000	AMORTISSEUR EN CAOUTCHOUC		
	176	945634 00000	GOUPILLE FILETEE		
	178	951602 00000	ECROU A ANNEAU		
	182	014902 21100	BRIDES		
	184	951916 00000	PROTECTION EN CAOUTCHOUC		
	185	948772 00000	RIVET TUBE		
	186	947508 00000	RONDELLE		
	188	945333 00000	VIS HEXAGONALE INTERNE		
	190	951018 00000	PRISONNIER		
	191	947506 00000	RONDELLE		
	192	947106 00000	ECROU A 6 PANS		
	195	902108 00000	ACCOUPLLEMENT		
	196	902209 00000	DISQUE D'ACCOUPLLEMENT		
	197	544501 21100	ACCOUPLLEMENT AVEC VENTILATEUR		
	285	728000 99622	SOUPAPE REGLAGE PRESSION / 0,6 BAR		
	285	728001 99622	SOUPAPE REGLAGE PRESSION / 1,0 BAR		
	285	728002 99622	SOUPAPE REGLAGE PRESSION / 2,0 BAR		
	288	948066 00000	JOINT		
	290	964307 00000	TUBE SILENCIEUX		
	291	912805 00000	BOUCHON		
		960000 02300	<b>GRAISSE, AMBLYGON TA15/2 (TUBE, 8g)</b>		



<sup>1)</sup> Jeu de joints - 54900021100 - Pos.: 20, 24, 62, 75, 76, 85, 86, 104, 125, 126, 127, 146, 288

<sup>2)</sup> quantité nécessaire / entretien





D INDICE	Pos.	No. Identificazione	Designazione
<b>KDT 3.60</b>	■	549000 21100	<b>SERIE DI GUARNIZIONE <sup>1)</sup></b>
	6	000100 21600	CARASSA
	9	020004 21100	ROTORE
	11	901330 00004	<b>PALETTE DI CHARBONE (KIT) <sup>2)</sup></b>
	15	000801 21100	COPERCHIO
	16	000701 21100	COPERCHIO
	18	001100 21200	COPERCHIO CUSCINETTO
	19	001000 21100	COPERCHIO CUSCINETTO
	20	025511 21100	GUARNIZIONE
	24	911312 00000	GUARNIZIONE
	26	917152 00000	DISCO COMPENSATORE
	27	906540 00000	GUARNIZIONE PER L'ALBERO
	28	906612 50000	CUSCINETTO A SFERA
	29	906657 00000	CUSCINETTO A SFERA
	31	511400 10100	SERIE DISCO GIUOCO
	37	945217 00000	VITE ESAGONALE
	38	016801 21100	DISCO DI FISSAGIO
	39	949807 00000	VITE
	41	945224 00000	VITE ESAGONALE
	42	945222 00000	VITE ESAGONALE
	45	948742 00000	PERNO
	47	947736 00000	CHIAVETTA
	50	053201 21100	FLANGIA DI RACCORDE
	52	950308 00000	RONDELLA
	53	945337 00000	VITE ESAGONALE INTERNA
	57	949409 00000	RONDELLA
	58	945270 00000	VITE DI CHIUSURA ALBERO
	61	040101 21100	CARASSA DEL FILTRO
	62	025501 21100	GUARNIZIONE
	64	946955 00000	PRIGIONIERO
	65	951003 00000	L'ASTA A VITE
	67	964407 00000	TUBO SILENZIATORE
	68	909507 00000	<b>CARTUCCIA FILTRO C 1112/2 (1x) <sup>2)</sup></b>
	71	009000 27000	MOLLA
	72	948750 00000	RIVETTO CIECO
	73	040201 21100	COPERCHIO FILTRO
	75	025518 21100	GUARNIZIONI
	76	025516 21100	GUARNIZIONE
	77	022802 21100	SUPPORTO FILTRO
	79	945321 00000	VITE ESAGONALE INTERNA
	80	946971 00000	L'ASTA A VITE
	81	947504 00000	RONDELLA
	82	947104 00000	DADO ESAGONALE
	83	952019 00000	SPINE DI RISCONTRO
	85	025514 21100	GUARNIZIONE
	86	025515 21100	GUARNIZIONE
	88	560203 21100	RAFFREDDATORE
	91	909510 00000	<b>CARTUCCIA FILTRO C 713 (1x) <sup>2)</sup></b>
	93	946965 00000	L'ASTA A VITE
	94	947105 00000	DADO ESAGONALE
	95	949450 00000	RONDELLA
	97	950304 00000	RONDELLA
	98	945322 00000	VITE ESAGONALE INTERNA
	103	068801 21100	COPERCHIO
	104	025513 21100	GUARNIZIONE
	105	945319 00000	VITE ESAGONALE INTERNA
	110	921500 50000	MANETTA
	121	560204 21100	RAFFREDDATORE
	125	025504 21100	GUARNIZIONE

D INDICE	Pos.	No. Identificazione	Designazione
	126	025512 21100	GUARNIZIONE
	127	025517 21100	GUARNIZIONI
	129	945372 00000	VITE ESAGONALE INTERNA
	130	945328 00000	VITE ESAGONALE INTERNA
	132	946930 00000	L'ASTA A VITE
	134	005602 21100	COPERCHIO
	141	016606 21100	PEZZI RACCORDI
	146	025507 21100	GUARNIZIONE
	148	945368 00000	VITE ESAGONALE INTERNA
	149	741310 30000	AMMORTIZZATORE IN GOMMA
	161	918300 21100	CARTER
	163	920800 21100	CAPPOTTA DEL CONDOTTA ARIA
	165	960700 21100	CAPPOTTA DEL VENTILATORE
	166	960701 21100	CAPPOTTA DEL VENTILATORE
	170	945321 00000	VITE ESAGONALE INTERNA
	171	945371 00000	VITE ESAGONALE INTERNA
	173	949806 00000	VITE A TESTA SVASATA
	174	951703 00000	DISCO A MOLLA
	175	741302 00000	AMMORTIZZATORE IN GOMMA
	176	945634 00000	SPINA FILETTATURA
	178	951602 00000	GOLFARE CON FORO FILETTATO
	182	014902 21100	FLANGE
	184	951916 00000	PROTEZIONE IN GOMMA
	185	948772 00000	CHiodo TUBOLARE
	186	947508 00000	RONDELLA
	188	945333 00000	VITE ESAGONALE INTERNA
	190	951018 00000	L'ASTA A VITE
	191	947506 00000	RONDELLA
	192	947106 00000	DADO ESAGONALE
	195	902108 00000	GIUNTO
	196	902209 00000	DISCO GIUNTO
	197	544501 21100	GIUNTO CON VENTILATORE
	285	728000 99622	VALVOLA REGOLAZ.PRESSIONE / 0,6 BAR
	285	728001 99622	VALVOLA REGOLAZ.PRESSIONE / 1,0 BAR
	285	728002 99622	VALVOLA REGOLAZ.PRESSIONE / 2,0 BAR
	288	948066 00000	ANELLO GUARNIZIONE
	290	964307 00000	TUBO SILENZIATORE
	291	912805 00000	TAPPO DI CHIUSURA
		960000 02300	<b>GRASSO, AMBLYGON TA15/2 (TUBETTO, 8g)</b>

<sup>1)</sup> Serie di guarnizione - 54900021100 - Pos.: 20, 24, 62, 75, 76, 85, 86, 104, 125, 126, 127, 146, 288

<sup>2)</sup> quantità di ordinazione necessari / manutenzione

D INDICE	Pos.	No. De pedido	Descripción	
<b>KDT 3.60</b>	□	549000 21100	<b>JUNTA COMPLETA <sup>1)</sup></b>	
	6	000100 21600	CARCASA	
	9	020004 21100	ÉMBOLO	
	11	901330 00004	<b>EMPUJADOR (KIT) <sup>2)</sup></b>	
	15	000801 21100	TAPA LATERAL	
	16	000701 21100	TAPA LATERAL	
	18	001100 21200	TAPA DE COJINETE LADO A	
	19	001000 21100	TAPA DE COJINETE LADO B	
	20	025511 21100	JUNTA	
	24	911312 00000	MANGUERA DE JUNTA	
	26	917152 00000	ARANDELA DE COMPENSACIÓN	
	27	906540 00000	ANILLO DE JUNTA DE ÁRBOL	
	28	906612 50000	COJINETE DE RODAMIENTO 3205 2RS C3 TA	
	29	906657 00000	COJINETE DE RODAMIENTO NU 205/ZS	
	31	511400 10100	JUEGO DE ARANDELAS DISTANCIADORAS	
	37	945217 00000	TORNILLO DE CABEZA HEXAGONAL	
	38	016801 21100	ARANDELA TENSORA	
	39	949807 00000	TORNILLO AVELLANADO	
	41	945224 00000	TORNILLO DE CABEZA HEXAGONAL	
	42	945222 00000	TORNILLO DE CABEZA HEXAGONAL	
	45	948742 00000	PASADOR ENTALLADO DE AJUSTE	
	47	947736 00000	LENGÜETA DE AJUSTE	
	50	053201 21100	FAROL	
	52	950308 00000	ARANDELA	
	53	945337 00000	TORNILLO HEXAGONAL INTERIOR	
	57	949409 00000	ARANDELA	
	58	945270 00000	TORNILLO TERMINAL DE ÁRBOL	
	61	040101 21100	CARCASA DE FILTRO	
	62	025501 21100	JUNTA	
	64	946955 00000	ESPÁRRAGO	
	65	951003 00000	ESPÁRRAGO	
	67	964407 00000	TUBO DE SILENCIADOR	
	68	909507 00000	<b>CARTUCHO DE FILTRO C 1112/2 (1x) <sup>2)</sup></b>	
	71	009000 27000	MUELLE DE PRESIÓN	
	72	948750 00000	REMACHE CIEGO	
	73	040201 21100	TAPA DE FILTRO	
	75	025518 21100	JUNTA	
	76	025516 21100	JUNTA	
	77	022802 21100	SOPORTE DE FILTRO	
	79	945321 00000	TORNILLO HEXAGONAL INTERIOR	
	80	946971 00000	ESPÁRRAGO	
	81	947504 00000	ARANDELA	
	82	947104 00000	TUERCA HEXAGONAL	
	83	952019 00000	CASQUILLO TENSOR	
	85	025514 21100	JUNTA	
	86	025515 21100	JUNTA	
	88	560203 21100	REFRIGERADOR	
	91	909510 00000	<b>CARTUCHO DE FILTRO C 713 (1x) <sup>2)</sup></b>	
	93	946965 00000	ESPÁRRAGO	
	94	947105 00000	TUERCA HEXAGONAL	
	95	949450 00000	ARANDELA	
	97	950304 00000	ARANDELA	
	98	945322 00000	TORNILLO HEXAGONAL INTERIOR	
	103	068801 21100	TAPA	
	104	025513 21100	JUNTA	
	105	945319 00000	TORNILLO HEXAGONAL INTERIOR	
	110	921500 50000	EMPUÑADURA	
	121	560204 21100	REFRIGERADOR	
	125	025504 21100	JUNTA	



D INDICE	Pos.	No. De pedido	Descripción	
	126	025512 21100	JUNTA	
	127	025517 21100	JUNTA	
	129	945372 00000	TORNILLO HEXAGONAL INTERIOR	
	130	945328 00000	TORNILLO HEXAGONAL INTERIOR	
	132	946930 00000	ESPÁRRAGO	
	134	005602 21100	TAPA	
	141	016606 21100	PIEZA DE EMPALME	
	146	025507 21100	JUNTA	
	148	945368 00000	TORNILLO HEXAGONAL INTERIOR	
	149	741310 30000	AMORTIGUADOR DE GOMA	
	161	918300 21100	CAPERUZA DE RECUBRIMIENTO	
	163	920800 21100	CAPERUZA CONDUCTOR DE AIRE	
	165	960700 21100	CAPERUZA DE VENTILADOR	
	166	960701 21100	CAPERUZA DE VENTILADOR	
	170	945321 00000	TORNILLO HEXAGONAL INTERIOR	
	171	945371 00000	TORNILLO HEXAGONAL INTERIOR	
	173	949806 00000	TORNILLO AVELLANADO	
	174	951703 00000	ARANDELA ELÁSTICA	
	175	741302 00000	AMORTIGUADOR DE GOMA	
	176	945634 00000	VARILLA ROSCADA	
	178	951602 00000	TUERCA DE CÁNCAMO	
	182	014902 21100	BRIDA INTERMEDIA	
	184	951916 00000	BOQUILLA DE CABLE	
	185	948772 00000	REMACHE TUBULAR	
	186	947508 00000	ARANDELA	
	188	945333 00000	TORNILLO HEXAGONAL INTERIOR	
	190	951018 00000	ESPÁRRAGO	
	191	947506 00000	ARANDELA	
	192	947106 00000	TUERCA HEXAGONAL	
	195	902108 00000	MITAD DE ACOPLAMIENTO (MOT)	
	196	902209 00000	DISCO DE ACOPLAMIENTO / AMARILLO	
	197	544501 21100	ACOPLAMIENTO DE SOPLADO CON VÁLVULA	
	285	728000 99622	VÁLVULA REGULADORA DE PRESIÓN / 0,6 BAR	
	285	728001 99622	VÁLVULA REGULADORA DE PRESIÓN / 1,0 BAR	
	285	728002 99622	VÁLVULA REGULADORA DE PRESIÓN / 2,0 BAR	
	288	948066 00000	ANILLO DE JUNTA	
	290	964307 00000	TUBO DE SILENCIADOR	
	291	912805 00000	TAPÓN DE DESGASTE	
		960000 02300	<b>GRASA, AMBLYGON TA15/2 (TUBO, 8g)</b>	
				

<sup>1)</sup> Junta completa - 54900021100 - Pos.: 20, 24, 62, 75, 76, 85, 86, 104, 125, 126, 127, 146, 288  
<sup>2)</sup> cantidad necesario / mantenimiento

KDT 3.60	Variante 	Pos. <sup>2)</sup>	Bestell Nr. / Ident No. / No. Identification / No. Identificazione / No. De pedido		Beschreibung / Description / Designation / Designazione / Desripcion
① US-motor		190		951018-00000	STIFTSCHRAUBE / STUD / PRISONNIER / L'ASTA A VITE / ESPÁRRAGO
		191		947506-00000	UNTERLEGSCHLEIBE / WASHER / RONDELLE / RONDELLA / ARANDELA
		192		947106-00000	SECHSKANTMUTTER / HEX.NUT / ECROU A 6 PANS / DADO ESAGONALE / TUERCA HEXAGONAL
		195	902100 21100	902108-00000	MOTORKUPPLUNG / COUPLING / ACCOUPLEMENT / GIUNTO / ACOPLAMIENTO
② /0-05 - Korrosionsschutz - corrosion protection - protection contre la corrosion - protezione anti-corrosione - protección contra la corrosión		9	020005 21100	020004-21100	KOLBEN / ROTOR / PISTON / ROTORE / ÉMBOLO
③ /6 - Korrosionsschutz - corrosion protection - protection contre la corrosion - protezione anti-corrosione - protección contra la corrosión		6	000110 21600	000100-21600	GEHÄUSE / PUMP BODY / CORP DE POMPE / CARCASSA / CARCASA
		9	020011 21100	020004-21100	KOLBEN / ROTOR / PISTON / ROTORE / ÉMBOLO
		11	901379 00004	901330-00004	<b>SATZ (KIT)</b> SCHIEBER / VANES / PALETTE / PALETTE / EMPUJADOR
		15	000811 21100	000801-21100	SEITENDECKEL / LID LATERAL / COUVERCLE LATÉRAL / COPERCHIO LATERALE / TAPA LATERAL
		16	000711 21100	000701-21100	SEITENDECKEL / LID LATERAL / COUVERCLE LATÉRAL / COPERCHIO LATERALE / TAPA LATERAL
		68	909587 00000	909507-00000	FILTERPATRONE / FILTER CARTRIDGE / CARTOUCHE FILTRE / CARTUCCIA FILTRO / CARTUCHO DE FILTRO
④ /6-29 - Korrosionsschutz - corrosion protection - protection contre la corrosion - protezione anti-corrosione - protección contra la corrosión		6	000110 21600	000100-21600	GEHÄUSE / PUMP BODY / CORP DE POMPE / CARCASSA / CARCASA
		9	020012 21100	020004-21100	KOLBEN / ROTOR / PISTON / ROTORE / ÉMBOLO
		11	901379 00007	901330-00004	<b>SATZ (KIT)</b> SCHIEBER / VANES / PALETTE / PALETTE / EMPUJADOR
		15	000811 21100	000801-21100	SEITENDECKEL / LID LATERAL / COUVERCLE LATÉRAL / COPERCHIO LATERALE / TAPA LATERAL
		16	000711 21100	000701-21100	SEITENDECKEL / LID LATERAL / COUVERCLE LATÉRAL / COPERCHIO LATERALE / TAPA LATERAL
		68	909587 00000	909507-00000	FILTERPATRONE / FILTER CARTRIDGE / CARTOUCHE FILTRE / CARTUCCIA FILTRO / CARTUCHO DE FILTRO
⑤ /0-52 - Korrosionsschutz - corrosion protection - protection contre la corrosion - protezione anti-corrosione - protección contra la corrosión		9	020005 21100	020004-21100	KOLBEN / ROTOR / PISTON / ROTORE / ÉMBOLO
		11	901379 00004	901330-00004	<b>SATZ (KIT)</b> SCHIEBER / VANES / PALETTE / PALETTE / EMPUJADOR
		285		72800X-99622	DRUCKREGULIERVENTIL / PRESSURE REGULATING VALVE / SOUPAPE REGLAGE PRESSION / VALVOLA REGOLAZIONE PRESSIONE / VÁLVULA REGULADORA DE PRESIÓN
		403	734000 02000		DRUCKREGULIERVENTIL 2,2 BAR / PRESSURE REGULATING VALVE 32 PSI / SOUPAPE REGLAGE PRESSION 2,2 BAR / VALVOLA REGOLAZIONE PRESSIONE 2,2 BAR / VÁLVULA REGULADORA DE PRESIÓN 2,2 BAR
⑥ /0-54 - Kühlung - refrigeration - réfrigération - refrigerazione - refrigeración		88		560203-21100	KÜHLER / COOLER / REFROIDISSEUR / RAFFREDDATORE / REFRIGERADOR
		166		960701-21100	LÜFTERHAUBE / VENTILATOR HOOD / CARTER DE VENTILATEUR / CAPPOTTA DEL VENTILATORE / CAPERUZA DE VENTILADOR
		210	560700 21100		LÜFTERHAUBE / VENTILATOR HOOD / CARTER DE VENTILATEUR / CAPPOTTA DEL VENTILATORE / CAPERUZA DE VENTILADOR
		230	019901 21100		UMLENKSTÜCK / RETURN PIECE / PIECE DE RETOUR / PEZZO INVERSIONE / PIEZA DE DESVIACIÓN

<sup>2)</sup> variantenabhängige Bauteile / variant-dependent components / composants variante-dependantes / componenti variante-dispendenti / componentes variante-dependientes



KDT 3.60	Variante 	Pos. <sup>2)</sup>	Bestell Nr. / Ident No. / No. Identification / No. Identificazione / No. De pedido		Beschreibung / Description / Designation / Designazione / Desripcion
					
⑦ /B5/200 - Motoranschluß - motor flange - bride de moteur - flangia del motore - brida de motor		182	014900 21600	014900 21100	ZWISCHENFLANSCH / INTERMEDIATE FLANGE / BRIDE INTERMEDIAIRE / FLANGE INTERMEDIA / BRIDA INTERMEDIA
		195	902100 21600	902100 00000	MOTORKUPPLUNG / COUPLING / ACCOUPLEMENT / GIUNTO / ACOPLAMIENTO

<sup>2)</sup> variantenabhängige Bauteile / variant-dependent components / composants variante-dependantes / componenti variante-dispendenti / componentes variante-dependientes